

深圳市安普盛科技有限公司

HMCORE

地址：深圳市南山区西丽街道留仙四街深圳国际创新谷 8 栋 A 座 1505 室

电话：0755-86185128

## Data Sheet

—For

编号	N20221116
品牌	HMCORE
品名	HLR2
安普盛型号	HFR23-U-B1-G
客户料号	
客户型号	
制作	WU
审核	Xzz, Siya
批准	Sky
日期	2022.11.16

客户承认签印	
日期	

UNLESS OTHER SPECIFIED TOLERANCES ON: X=±      X.X=±      X.XX=			深圳市安普盛科技有限公司	
ANGLES = ±      HOLE DIA = ±			THIS DRAWINGS AND SPECIFICATIONS ARE THE PROPERTY OF HONMAX TECHNOLOGY Limited AND SHALL NOT BE REPRODUCED OR USED AS THE BASIS FOR THE MANUFACTURE OR SALE OF APPARATUS OR DEVICES WITHOUT PERMISSION	
SCALE: N/A	UNIT: mm			
DRAWN BY: WU	CHECKED BY: Xzz, Siya			
DESIGNED BY: WU	APPROVED BY: Sky			
TITLE: HFR23-U Data Sheet		DOCUMENT NO.	N20221116	SPEC REV. R1



## HFR23-U Data Sheet

### 1. 产品特性:

- 轻巧、紧凑
- K波段
- 低成本
- 可隐藏安装
- 不受温度、噪声、气流、尘埃、光线等环境因素影响，抗干扰强

### 2. 应用场景:

- 楼宇、智能家居
- 灯光控制
- 工业机器人（制造机器人）

### 3. 产品型号命名规则:

HFR23-U-B1-G

- (1) H:HONMAX
- (2) F:F 系列
- (3) R:RADAR
- (4) U:串口通讯
- (5) B1:封装方式, B1 代表胶圈密封 1 号壳
- (6) G:线材型号

### 4. PCB 尺寸(单位: mm):

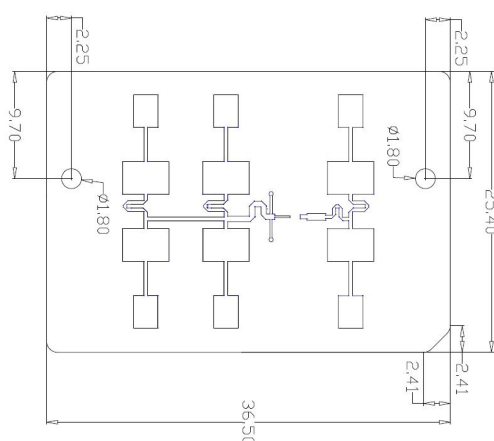

UNLESS OTHER SPECIFIED TOLERANCES ON: X=±      X.X=±      X.XX=		 <b>深圳市安普盛科技有限公司</b>	
ANGLES = ±      HOLE DIA = ±			
SCALE: N/A	UNIT: mm	THIS DRAWINGS AND SPECIFICATIONS ARE THE PROPERTY OF HONMAX TECHNOLOGY Limited AND SHALL NOT BE REPRODUCED OR USED AS THE BASIS FOR THE MANUFACTURE OR SALE OF APPARATUS OR DEVICES WITHOUT PERMISSION	
DRAWN BY: WU	CHECKED BY: Xzz, Siya		
DESIGNED BY: WU	APPROVED BY: Sky		
TITLE: HFR23-U Data Sheet	DOCUMENT NO.	N20221116	SPEC REV. R1



照片

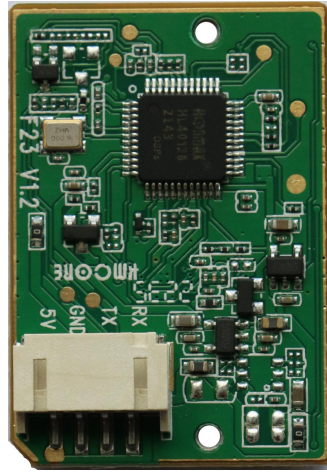

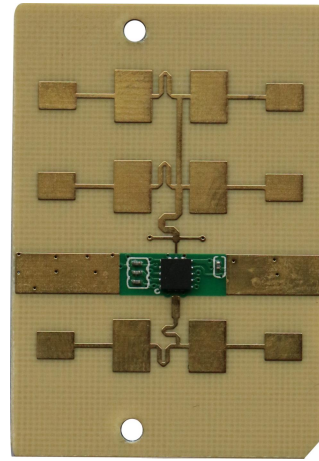

正面

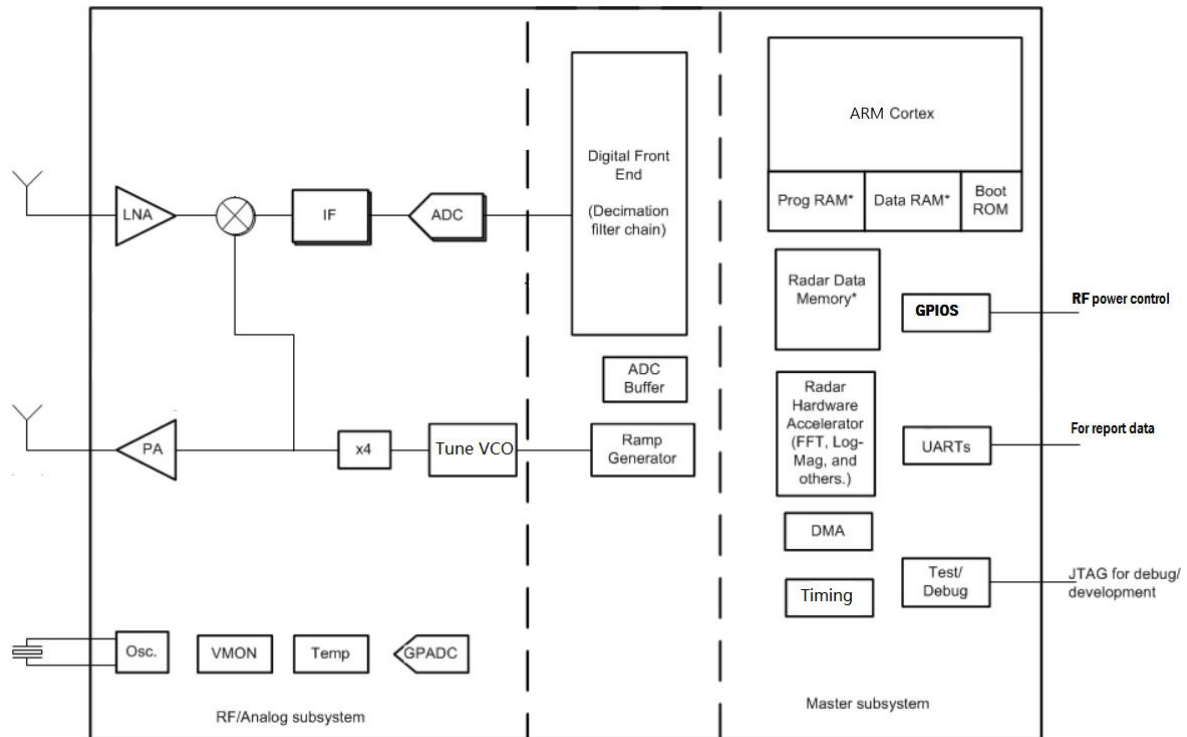

背面

5. 方框原理图:



UNLESS OTHER SPECIFIED TOLERANCES ON: $X = \pm$ $X.X = \pm$ $X.XX =$ <b>ANGLES = <math>\pm</math></b> <b>HOLE DIA = <math>\pm</math></b>		 <b>深圳市安普盛科技有限公司</b>		
SCALE: N/A	UNIT: mm			
DRAWN BY: WU	CHECKED BY: Xzz, Siya	THIS DRAWINGS AND SPECIFICATIONS ARE THE PROPERTY OF HONMAX TECHNOLOGY Limited AND SHALL NOT BE REPRODUCED OR USED AS THE BASIS FOR THE MANUFACTURE OR SALE OF APPARATUS OR DEVICES WITHOUT PERMISSION		
DESIGNED BY: WU	APPROVED BY: Sky			
TITLE: HFR23-U Data Sheet		DOCUMENT NO.	N20221116	SPEC REV. <b>R1</b>

## 6. 产品参数表:

HMCORE

参数条件	环境	最小值	典型值	最大值	单位
<b>System</b>					
工作频率		K-BAND			
输出功率 (TX output)	@ 25°C		5		mW
调制方式	FMCW				
更新时间			100		ms
通信接口		UART			
<b>Radar</b>					
检测距离	@0 dBsm			2	m
<b>Antenna</b>					
天线-6dB 波束	水平面角度(-6dB)		59		deg
	垂直面角度 (-6dB)		36		deg
<b>Other</b>					
工作电压		3.6	5	5.5	V
工作电流			70	<80	mA

UNLESS OTHER SPECIFIED TOLERANCES ON: X=±      X.X=±      X.XX= ANGLES = ±      HOLE DIA = ±		 <b>深圳市安普盛科技有限公司</b>		
SCALE: N/A	UNIT: mm			
DRAWN BY: WU	CHECKED BY: Xzz, Siya	THIS DRAWINGS AND SPECIFICATIONS ARE THE PROPERTY OF HONMAX TECHNOLOGY Limited AND SHALL NOT BE REPRODUCED OR USED AS THE BASIS FOR THE MANUFACTURE OR SALE OF APPARATUS OR DEVICES WITHOUT PERMISSION		
DESIGNED BY: WU	APPROVED BY: Sky			
TITLE: HFR23-U Data Sheet		DOCUMENT NO.	N20221116	SPEC REV. R1

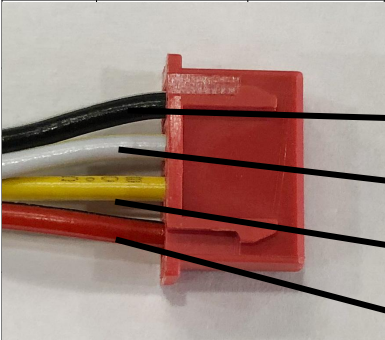

7.接口定义:

	PIN#	DESCRI	IN/OUT	COMMENT
	PIN1	GND	-	GND
	PIN2	TX	Output(OD)	TTL 兼容 3.3V/5V
	PIN3	RX	input	TTL 兼容 3.3V/5V
	PIN4	Power	input	3.6~5.5(V)

8. 线材规格(单位: mm):

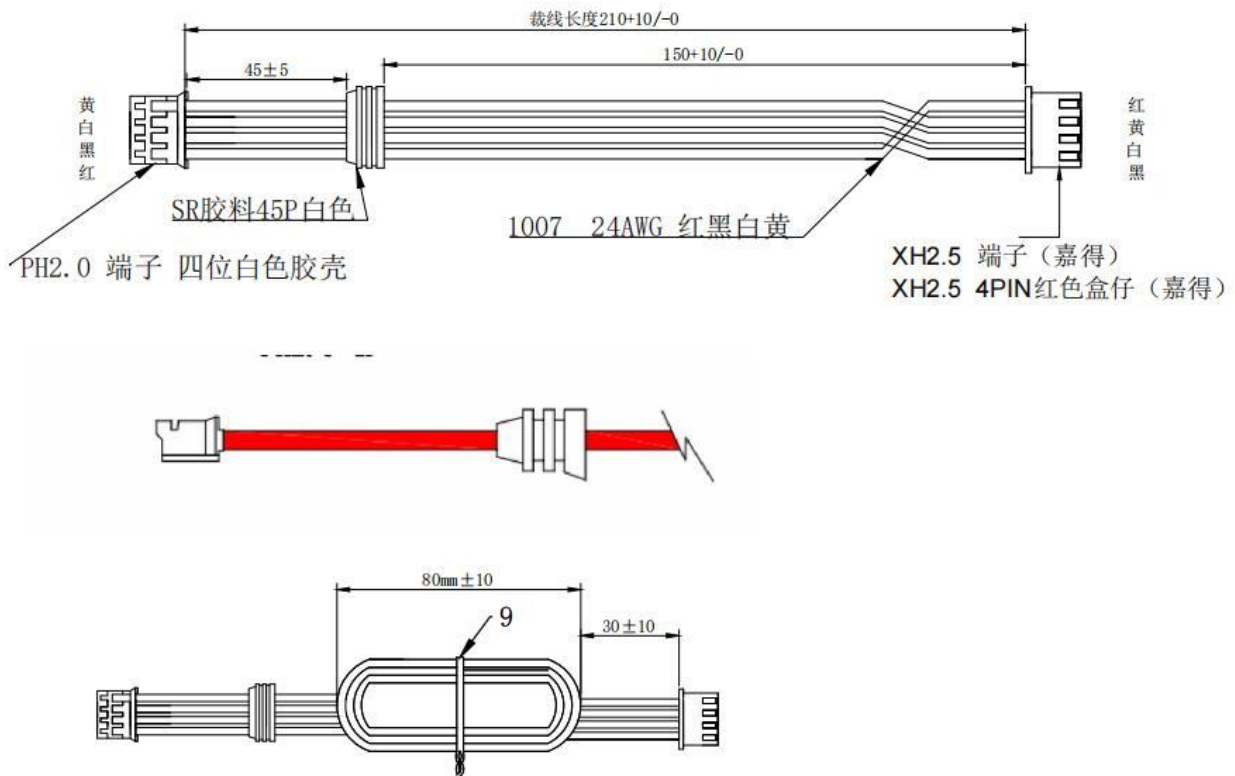

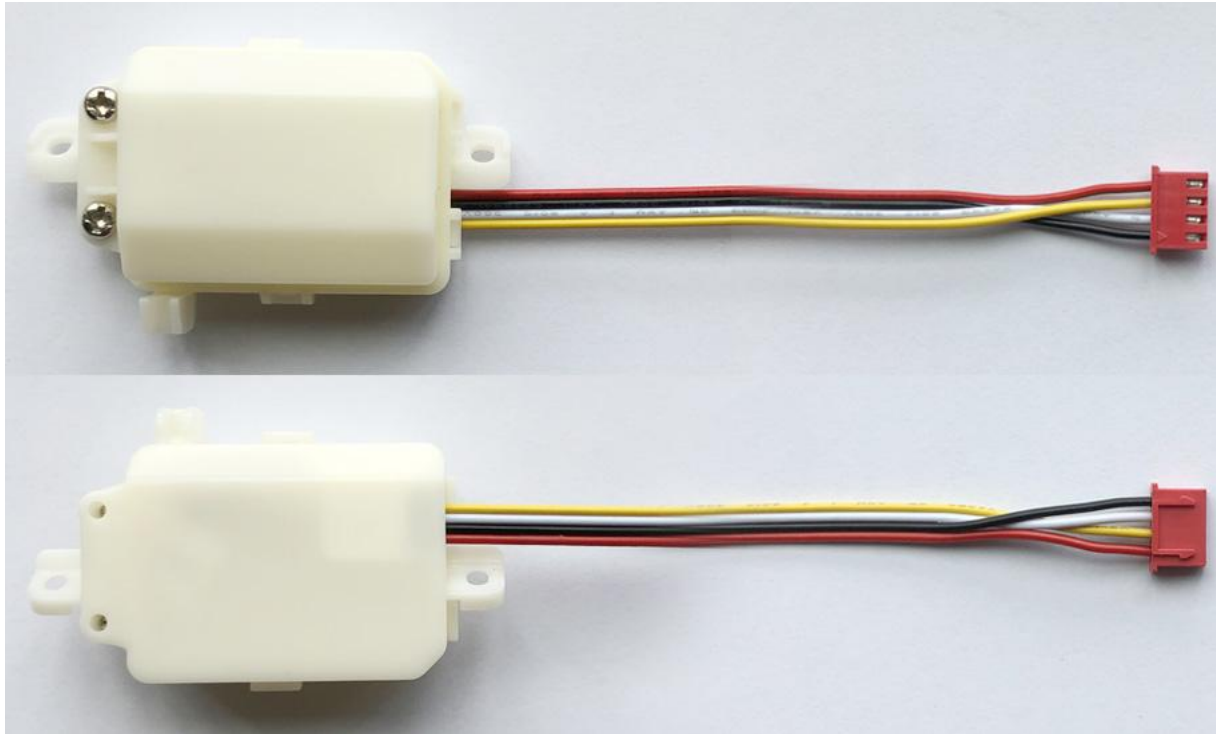

UNLESS OTHER SPECIFIED TOLERANCES ON: X=±      X.X=±      X.XX=		 <b>深圳市安普盛科技有限公司</b>	
ANGLES = ±      HOLE DIA = ±			
SCALE: N/A	UNIT: mm	THIS DRAWINGS AND SPECIFICATIONS ARE THE PROPERTY OF HONMAX TECHNOLOGY Limited AND SHALL NOT BE REPRODUCED OR USED AS THE BASIS FOR THE MANUFACTURE OR SALE OF APPARATUS OR DEVICES WITHOUT PERMISSION	
DRAWN BY: WU	CHECKED BY: Xzz, Siya		
DESIGNED BY: WU	APPROVED BY: Sky		
TITLE: HFR23-U Data Sheet	DOCUMENT NO.	N20221116	SPEC REV. R1

9. 装配实图:

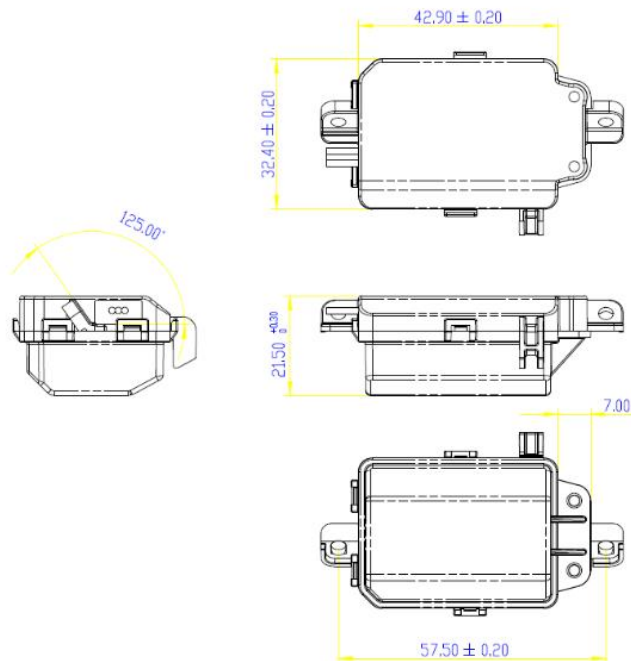

10. 外壳尺寸(单位: mm):



UNLESS OTHER SPECIFIED TOLERANCES ON: X=±      X.X=±      X.XX=		 <b>深圳市安普盛科技有限公司</b>
ANGLES = ±      HOLE DIA = ±		
SCALE: N/A	UNIT: mm	THIS DRAWINGS AND SPECIFICATIONS ARE THE PROPERTY OF HONMAX TECHNOLOGY Limited AND SHALL NOT BE REPRODUCED OR USED AS THE BASIS FOR THE MANUFACTURE OR SALE OF APPARATUS OR DEVICES WITHOUT PERMISSION
DRAWN BY: WU	CHECKED BY: Xzz, Siya	
DESIGNED BY: WU	APPROVED BY: Sky	
TITLE: HFR23-U Data Sheet		DOCUMENT NO.      N20221116      SPEC REV. R1



### 11. 安装角度:

装于马桶内，天线的法线与水平夹角一般为25-35°。

### 12. 注意事项:

#### 1、存储条件:

- ①为避免损坏电路，在存储、使用时都应采取ESD静电防护措施；
- ②产品在交付后应1年内被使用，存储温度适宜在0°C~30°C，湿度应小于60%RH。

#### 2、使用条件:

- ①请按照产品手册所示的电气参数（例如电压、电流等）范围内使用，如果超标使用，会降低产品的可靠性，并可能造成硬件永久性损坏，导致产品功能失效；
- ②安装前请将马桶断电，确认接线正确；
- ③可操作温度范围：-20°C to +70°C。

注：详见使用注意事项。

### 13. 协议:

串口默认波特率为1200，详见通讯协议文件。

### 14. 变更记录:

版本	变更内容	变更人	生效日期
2022/11/16	“首次发布”	WU	2022-11-16

UNLESS OTHER SPECIFIED TOLERANCES ON: X=±      X.X=±      X.XX= ANGLES = ±      HOLE DIA = ±		 <b>深圳市安普盛科技有限公司</b>
SCALE: N/A	UNIT: mm	
DRAWN BY: WU	CHECKED BY: Xzz, Siya	THIS DRAWINGS AND SPECIFICATIONS ARE THE PROPERTY OF HONMAX TECHNOLOGY Limited AND SHALL NOT BE REPRODUCED OR USED AS THE BASIS FOR THE MANUFACTURE OR SALE OF APPARATUS OR DEVICES WITHOUT PERMISSION
DESIGNED BY: WU	APPROVED BY: Sky	
TITLE: HFR23-U Data Sheet		DOCUMENT NO.      N20221116      SPEC REV. R1